

F1421

Description

The F1421 is a high gain / high linearity RF amplifier used in high-performance RF applications. The F1421 provides 20.3dB gain with a +40dBm OIP3 and 5.5dB noise figure at 1.9GHz. This device uses a single 5V supply and 138mA of I_{CC} .

In typical base stations, RF amplifiers are used in the RX and TX traffic paths to boost signal levels. The F1421 amplifier offers very high reliability due to its construction using silicon die in a QFN package.

Typical Applications

- Multi-mode, multi-carrier transmitters
- PCS1900 base stations
- DCS1800 base stations
- WiMAX and LTE base stations
- UMTS/WCDMA 3G base stations
- PHS/PAS base stations
- Public safety infrastructure

Features

- Broadband 1.7GHz to 2.2GHz
- 20.3dB typical gain at 1.9GHz
- 5.5dB noise figure at 1.9GHz
- +40dBm OIP3 at 1.9GHz
- +23dBm output P1dB at 1.9GHz
- Single 5V supply voltage
- $I_{CC} = 138\text{mA}$
- -40°C to $+105^{\circ}\text{C}$ operating temperature
- 50Ω single-ended input / output impedances
- Standby mode for power savings
- 4mm x 4mm, 24-pin QFN package

Block Diagram

Figure 1. Block Diagram

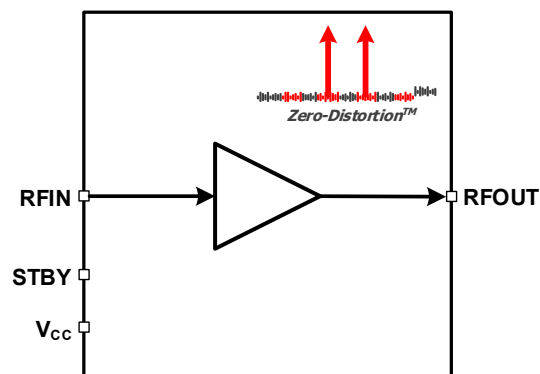

Pin Assignments

Figure 2. Pin Assignments for 4mm x 4mm x 0.9mm QFN Package – Top View

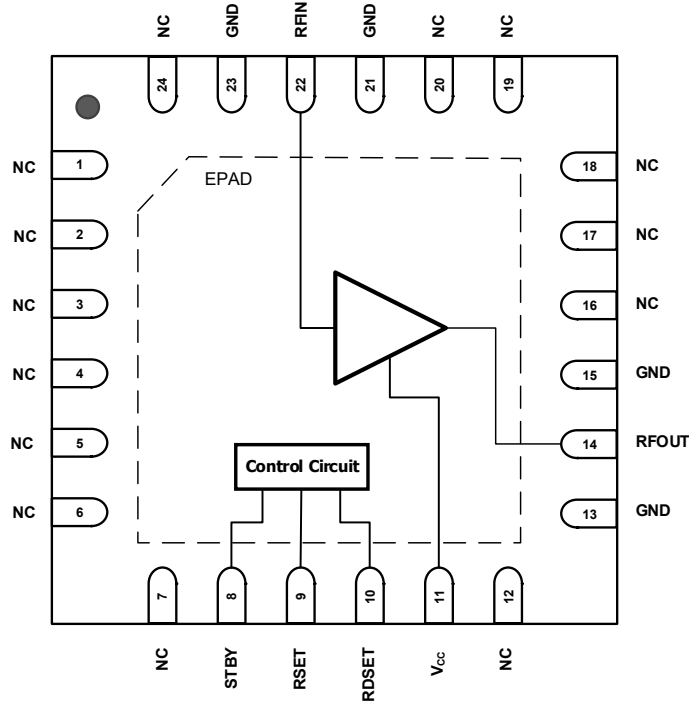

Pin Descriptions

Table 1. Pin Descriptions

Number	Name	Description
1 - 7, 12, 16 - 20, 24	NC	No internal connection. These pins can be left unconnected, have a voltage applied, or be connected to ground (recommended).
8	STBY	Standby (HIGH = device power OFF, LOW/Open = device power ON). Internally this pin has a pull-down resistor that is connected to GND.
9	RSET	Amplifier bias current setting resistor. Connect a 2.26kΩ resistor to ground.
10	RDSET	Amplifier second bias current setting resistor. Connect a 5.76kΩ resistor to ground.
11	V _{CC}	Power supply for the amplifier.
13, 15, 21, 23	GND	Internally grounded. These pins must be grounded as close to the device as possible.
14	RFOUT	RF output. Must use an external DC block as close to the pin as possible.
22	RFIN	RF input internally matched to 50Ω. Must use an external DC block. The DC block should be placed as close to the pin as possible for best RF performance.
	- EPAD	Exposed paddle. Internally connected to ground. Solder this exposed paddle to a printed circuit board (PCB) pad that uses multiple ground vias to provide heat transfer out of the device into the PCB ground planes. These multiple ground vias are also required to achieve the specified RF performance.

Absolute Maximum Ratings

The absolute maximum ratings are stress ratings only. Stresses greater than those listed below can cause permanent damage to the device. Functional operation of the F1421 at absolute maximum ratings is not implied. Exposure to absolute maximum rating conditions may affect device reliability.

Table 2. Absolute Maximum Ratings

Parameter	Symbol	Minimum	Maximum	Units
Supply Voltage	V_{CC}	-0.3	+5.5	V
STBY	V_{STBY}	-0.3	$V_{CC} + 0.25$	V
RFIN Externally Applied DC Voltage	V_{RFIN}	-0.3	+0.3	V
RFOUT Externally Applied DC voltage	V_{RFOUT}	$V_{CC} - 0.15$	$V_{CC} + 0.15$	V
Maximum RF CW Input Power	P_{MAX_IN}		+18	dBm
Continuous Power Dissipation	P_{DISS}		1.5	W
Junction Temperature	T_{JMAX}		+150	°C
Storage Temperature Range	T_{STOR}	-65	+150	°C
Lead Temperature (soldering, 10s)	T_{LEAD}		+260	°C
Electrostatic Discharge – HBM (JEDEC/ESDA JS-001-2012)	V_{ESDHMB}		2000 (Class 2)	V
Electrostatic Discharge – CDM (JEDEC 22-C101F)	V_{ESDCDM}		500 (Class C2)	V

Recommended Operating Conditions

Table 3. Recommended Operating Conditions

Parameter	Symbol	Condition	Minimum	Typical	Maximum	Units
Supply Voltage	V_{CC}		4.75		5.25	V
Operating Temperature Range	T_{EP}	Exposed Paddle	-40		+105	°C
RF Frequency Range	f_{RF}	Operating Range	1.7		2.2	GHz
Maximum Operating Input RF Power [a]	P_{IN_MAX}				+10	dBm
RF Source Impedance	Z_{RFI}	Single Ended		50		Ω
RF Load Impedance	Z_{RFO}	Single Ended		50		Ω

[a] Input / output load impedance < 2:1 VSWR any phase based in a 50 Ω system.

Electrical Characteristics

See the F1421 Typical Application Circuit. Specifications apply when operated at $V_{CC} = +5.0V$, $f_{RF} = 1.9GHz$, $T_{EP} = +25^{\circ}C$, $Z_S = Z_L = 50\Omega$, tone spacing = 5MHz, $P_{OUT} = +4dBm/$ tone, evaluation board (EVKit) traces and connectors are de-embedded, unless otherwise stated.

Table 4. Electrical Characteristics

Parameter	Symbol	Condition	Minimum	Typical	Maximum	Units
Logic Input High Threshold	V_{IH}		1.1 [a]		V_{CC}	V
Logic Input Low Threshold	V_{IL}				0.8	V
Logic Current	I_{IL}, I_{IH}	Standby Pin	-10		10	μA
Supply Current	I_{CC}	Standby = LOW or open		138	153	mA
	I_{CC_STBY}	Standby = HIGH		0.6	1.2	mA
Gain	$G_{1.7}$	$f_{RF} = 1.7GHz$		19.6		dB
	$G_{1.9}$	$f_{RF} = 1.9GHz$	18.8	20.3	21.8	
	$G_{2.2}$	$f_{RF} = 2.2GHz$		21.0		
Input Return Loss	RL_{IN}			15		dB
Output Return Loss	RL_{OUT}			15		dB
Gain Flatness	G_{FLAT}	$f_{RF} = 1.7GHz$ to $2.2GHz$		1.3		dB
Gain Ripple	G_{RIPPLE}	In any 20MHz range over RF Band		0.06		dB
Noise Figure	NF	$f_{RF} = 1.7GHz$		5.6		dB
		$f_{RF} = 1.9GHz$		5.5		
		$f_{RF} = 2.2GHz$		5.6		
		$f_{RF} = 1.9GHz, T_{EP} = +105^{\circ}C$		6.3		
Output Third Order Intercept Point	OIP3	$P_{OUT} = +4dBm/$ tone 5MHz tone delta	36	40		dBm
Output 1dB Compression	OP1dB		21	23		dBm
Power ON Switching Time	t_{ON}	50% STBY control to within 0.2dB of the on state final gain value		120		ns
Power OFF Switching Time	t_{OFF}	50% STBY control to 30dB below on state gain value		80		ns

[a] Specifications in the minimum/maximum columns that are shown in **bold italics** are guaranteed by test. Specifications in these columns that are not shown in bold italics are guaranteed by design characterization.

Thermal Characteristics

Table 5. Package Thermal Characteristics

Parameter	Symbol	Value	Units
Junction to Ambient Thermal Resistance	θ_{JA}	45	°C/W
Junction to Case Thermal Resistance (Case is defined as the exposed paddle)	θ_{JC-BOT}	36	°C/W
Moisture Sensitivity Rating (Per J-STD-020)		MSL 1	

Typical Operating Conditions (TOC)

- $V_{CC} = 5.0V$
- $Z_L = Z_S = 50\Omega$ Single Ended
- $f_{RF} = 1.9GHz$
- $T_{EP} = 25^\circ C$ (All temperatures are referenced to the exposed paddle)
- STBY = LOW (0V)
- $P_{OUT} = +4dBm/Tone$
- 5MHz Tone Spacing
- Evaluation Kit traces and connector losses are de-embedded

Typical Performance Characteristics

Figure 3. Gain vs Frequency

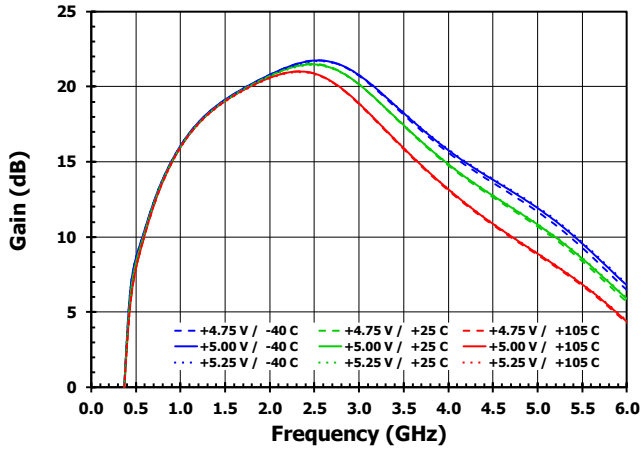

Figure 4. Reverse Isolation vs Frequency

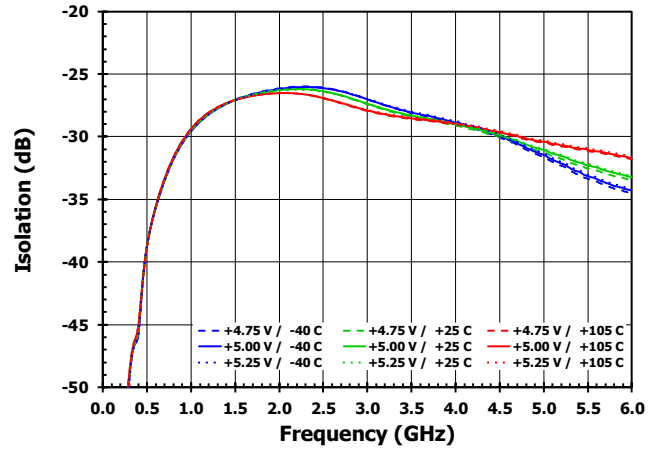

Figure 5. Input Return Loss vs Frequency

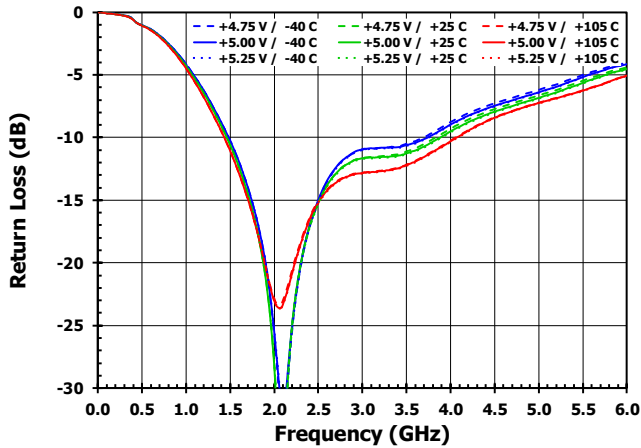

Figure 6. Output Return Loss vs Frequency

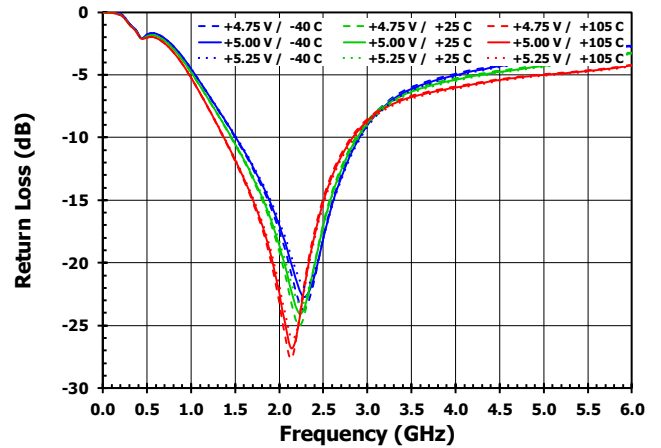

Figure 7. Gain vs Frequency

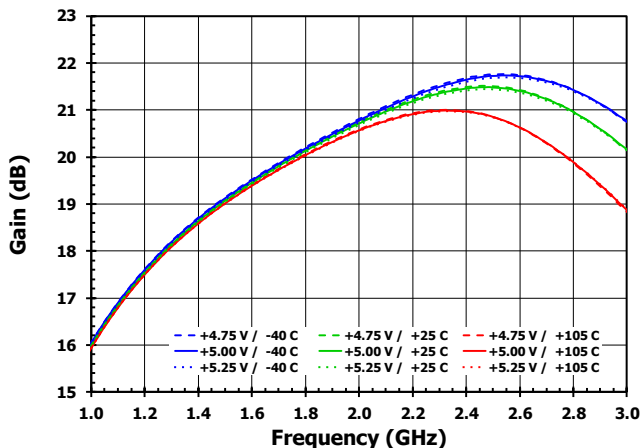
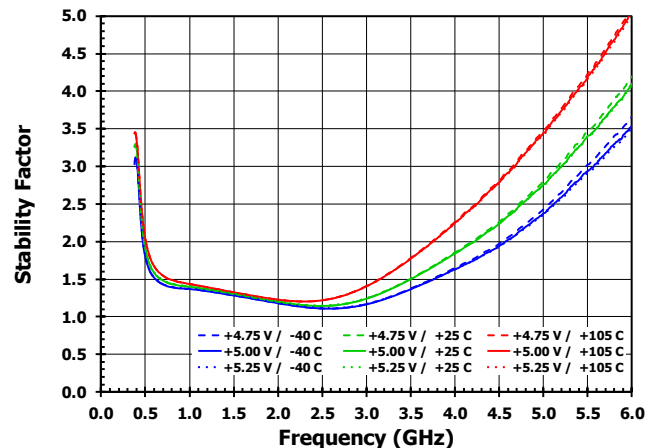

Figure 8. Stability vs Frequency



Typical Performance Characteristics

Figure 9. Output IP3 versus Frequency

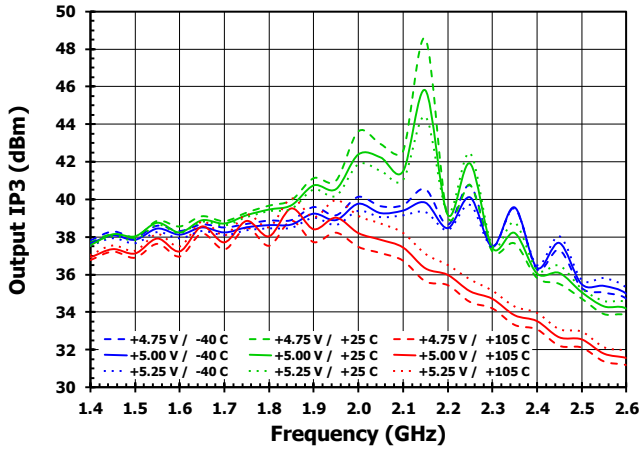

Figure 10. Output P1dB versus Frequency

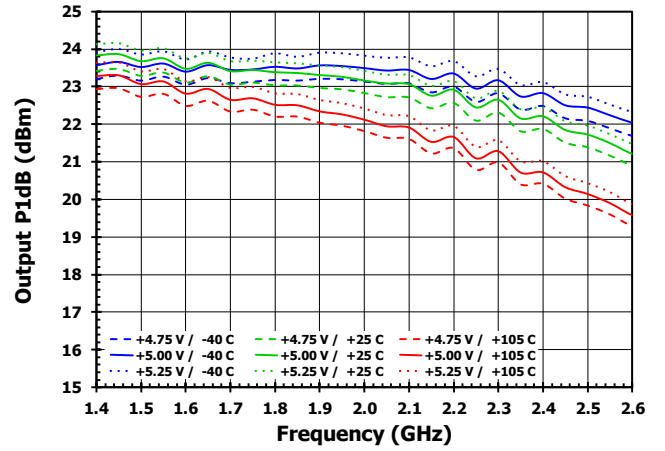

Figure 11. Second Harmonic versus Frequency

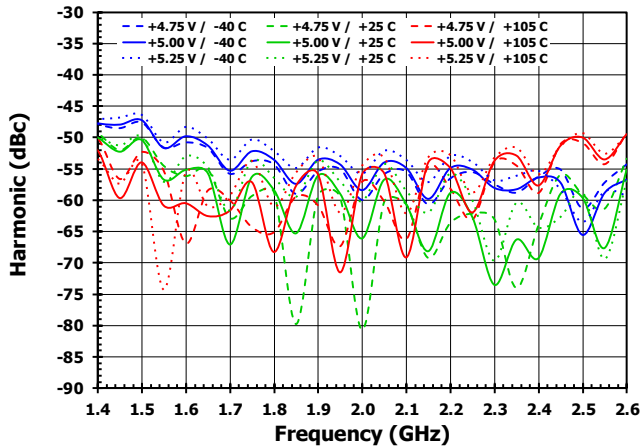

Figure 12. Third Harmonic versus Frequency

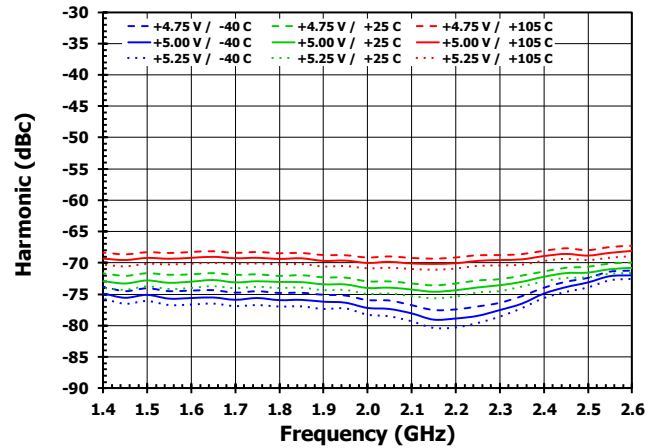

Figure 13. Noise Figure versus Frequency

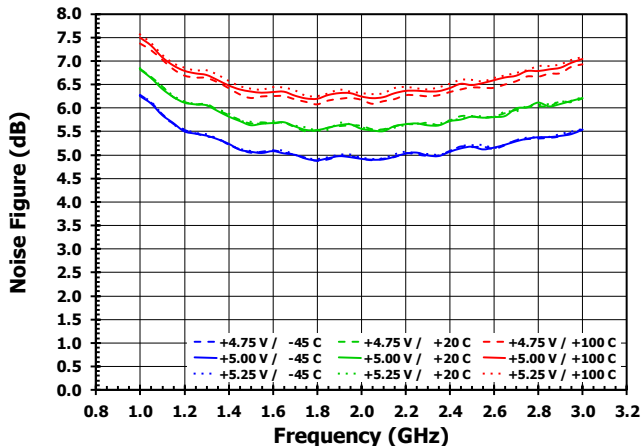
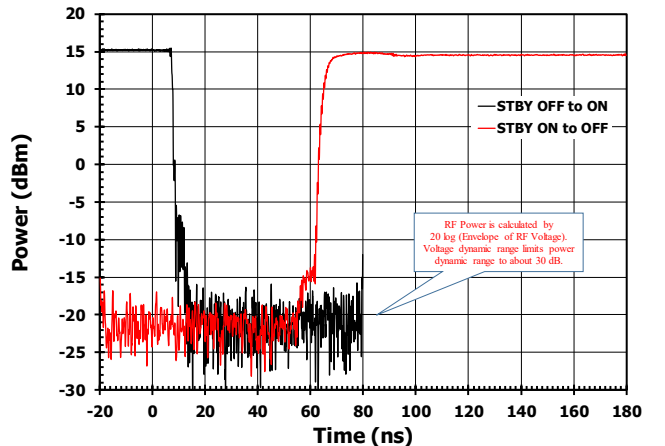

Figure 14. Standby Switching Speed



Evaluation Kit Picture

Note: The evaluation board is used for multiple devices.

Figure 15. Top View

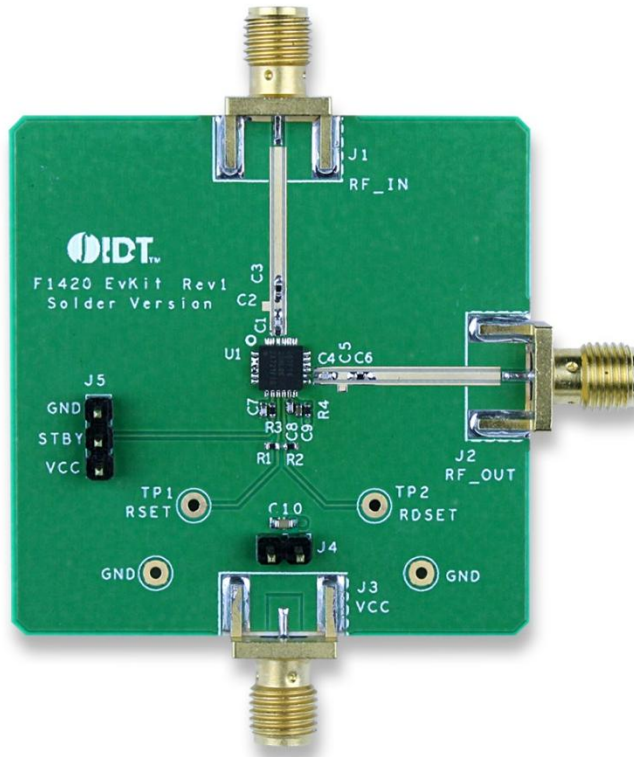
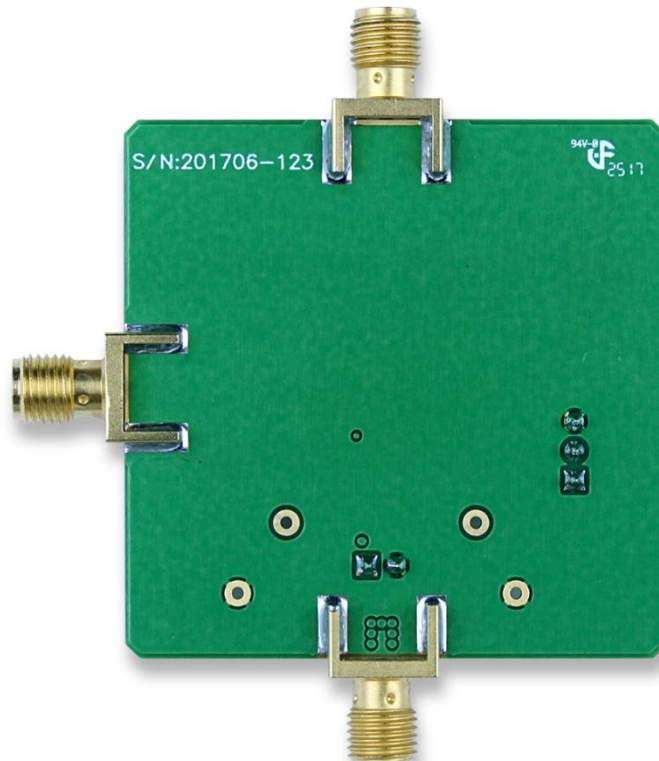

Figure 16. Bottom View



Evaluation Kit / Applications Circuit

Figure 17. Electrical Schematic

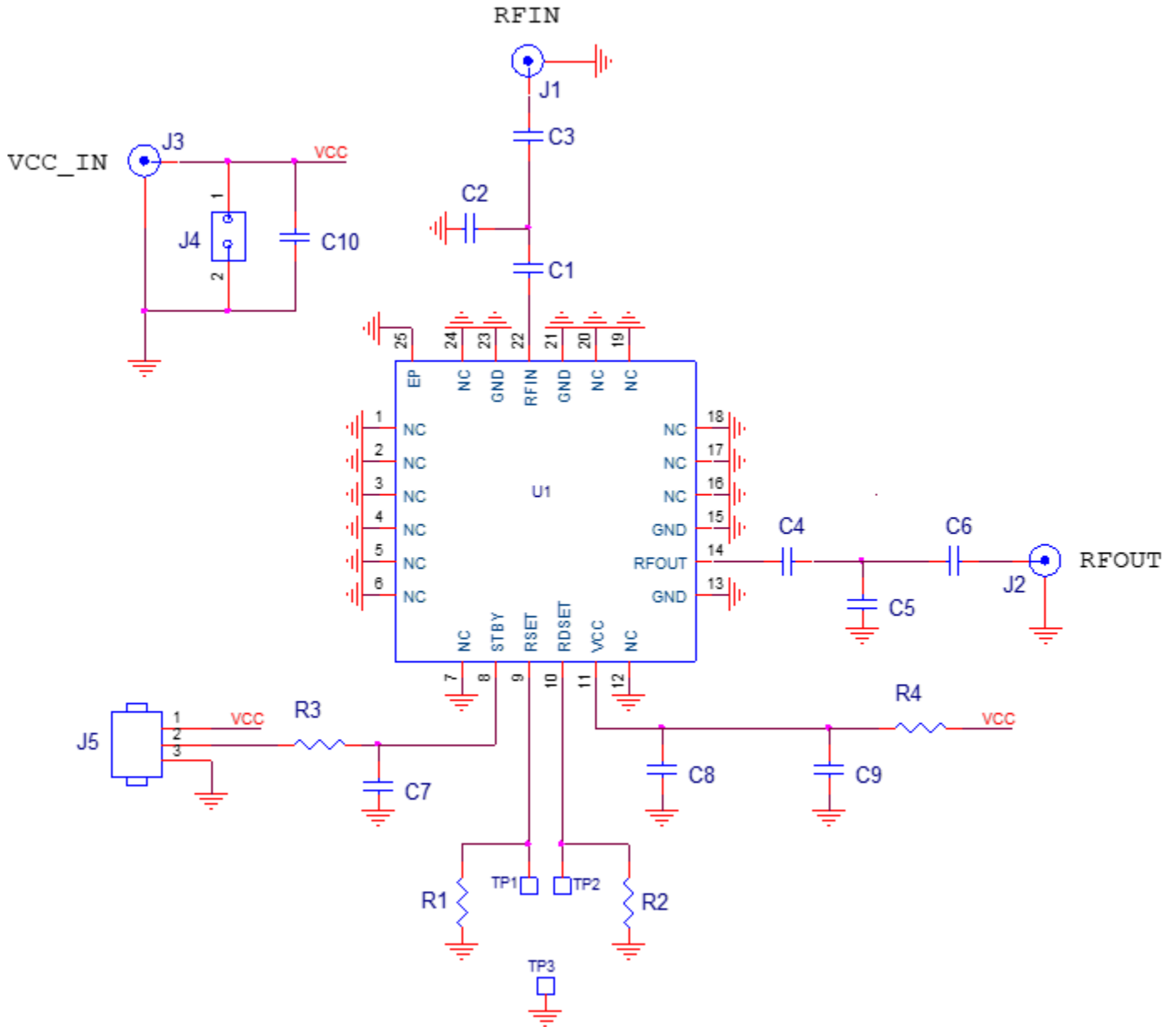

Table 6. Bill of Material (BOM)

Part Reference	QTY	Description	Manufacturer Part #	Manufacturer
C1	2	2.2pF ±0.1, 50V, C0G Ceramic Capacitor (0402)	GRM1555C1H2N20J	Murata
C4	2	4.0pF ±0.1, 50V, C0G Ceramic Capacitor (0402)	GRM1555C1H470J	Murata
C7	1	2pF ±0.1pF, 50V, C0G Ceramic Capacitor (0402)	GRM1555C1H2R0B	Murata
C8	1	1000pF ±5%, 50V, C0G Ceramic Capacitor (0402)	GRM1555C1H102J	Murata
C9	1	0.1µF ±10%, 16V, X7R Ceramic Capacitor (0402)	GRM155R71C104K	Murata
C10	1	10µF ±20%, 16V, X6S Ceramic Capacitor (0603)	GRM188C81C106M	Murata
R1	1	1.87kΩ ±1%, 1/10W, Resistor (0402)	ERJ-2RKF2001X	Panasonic
R2	1	5.11kΩ ±1%, 1/10W, Resistor (0402)	ERJ-2RKF3401X	Panasonic
R3	1	1kΩ ±1%, 1/10W, Resistor (0402)	ERJ-2RKF1001X	Panasonic
C3, C6, R4	3	0Ω Resistors (0402)	ERJ-2GE0R00X	Panasonic
J4	1	CONN HEADER VERT SGL 2 X 1 POS GOLD	961102-6404-AR	3M
J5	1	CONN HEADER VERT SGL 3 X 1 POS GOLD	961103-6404-AR	3M
J1, J2, J3	3	Edge Launch SMA (0.375 inch pitch ground, tab)	142-0701-851	Emerson Johnson
U1	1	AMP	F1421NLGK	AXIRO
	1	Printed Circuit Board	F1420 EVKit REV 1	AXIRO
C2, C5		DNP		

Evaluation Kit Operation

Power Supply Setup

Set up a power supply in the voltage range of 3.0V to 5.25V with the power supply output disabled. The voltage can be applied via one of the following connections (see Figure 18):

- J3 connector
- J4 header connection (GND is the pin farthest away from the J4 label)

Figure 18. Power Supply Connections

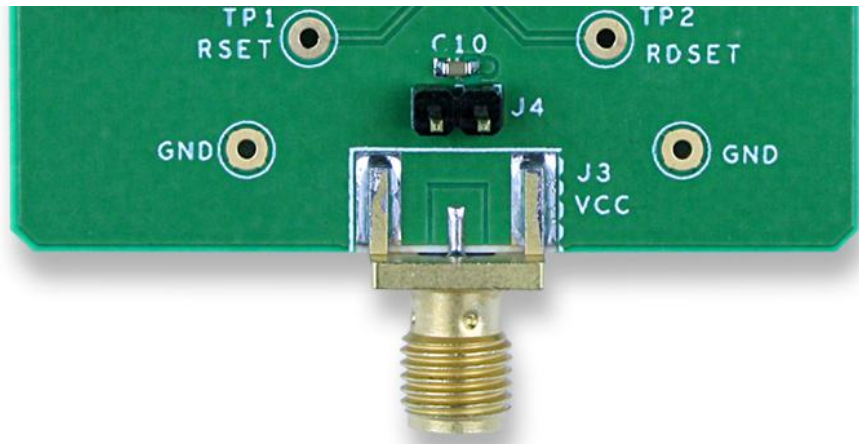

Standby (STBY) Pin

The Evaluation Board has the ability to control the F1421 for standby operation. The logic voltage is applied to the J5 header connection as shown in Figure 19.

To place the amplifier in the active mode (on) use one of these options:

- Make no connections on J5
- Apply a logic LOW signal to STBY (pin 2 of J5 or the middle pin).
- Make a connection between pin 3 (GND) and pin 2 (STBY, the middle pin) of J5.

To place the amplifier in the standby mode (off), use one of these options:

- Apply a logic HIGH signal to the STBY (pin 2 of J5 or the middle pin).
- Make a connection between pin 1 (VCC) and pin 2 (STBY, the middle pin) of J5.

Figure 19. Standby Pin Connection

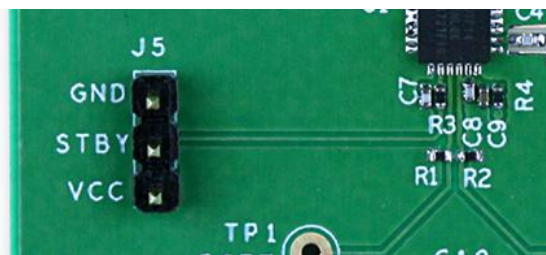

Power-On Procedure

Set up the voltage supplies and Evaluation Board as described in the "Power Supply Setup" section with the "Standby Pin" set for logic LOW.

- Enable the power supply.
- The STBY pin now can now be exercised.

Power-Off Procedure

- Set the STBY pin to logic LOW.
- Disable the power supply.

Application Information

The F1421 has been optimized for use in high-performance RF applications from 1.7GHz to 2.2GHz.

Standby Mode (STBY)

The F1421 has a standby pin which allows the amplifier to be turned off to decrease overall power requirements. The pin uses simple logic levels and is compatible with both JEDEC 1.8V and JEDEC 3.3V logic. Table 7 lists the amplifier state for the logic. An internal pull-down resistor causes the amplifier to default to the on state.

Table 7. Standby Truth Table

STBY (pin 8)	Condition
LOW or Open	Amplifier On
HIGH	Amplifier Off

RSET and RDSET

The F1421 has been optimized for gain and intermodulation products by adjusting the bias resistors RSET and RDSET. For the optimized setting, RSET (R1) is 1.87k Ω and RDSET (R2) is 5.11k Ω .

Power Supplies

The power supply pin should be bypassed with external capacitors to minimize noise and fast transients. Supply noise can degrade the noise figure, and fast transients can trigger ESD clamps and cause them to fail. Supply voltage changes or transients should have a slew rate less than 1V/20 μ s.

Control Pin Interface

If control signal integrity is a concern and clean signals cannot be guaranteed due to overshoot, undershoot, ringing, etc., the following circuit at the input of each control pin is recommended. This applies to control pin 8 (STBY). Note the recommended resistor and capacitor values do not necessarily match the EVKit BOM for the case of poor control signal integrity.

Figure 20. Control Pin Interface for Signal Integrity

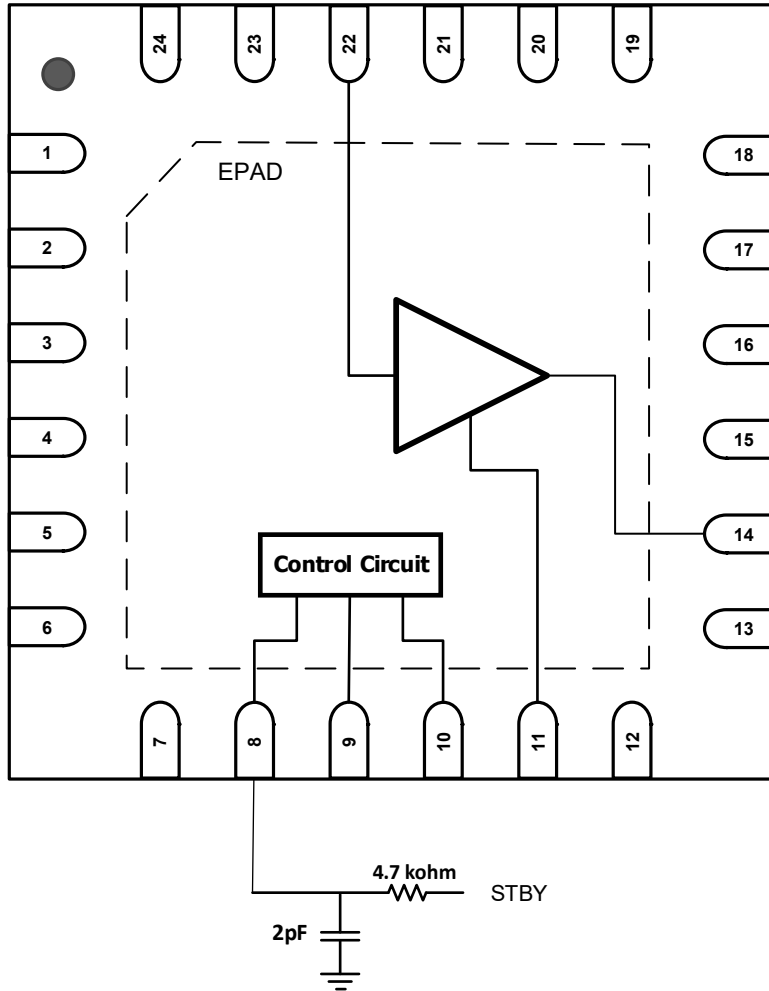

Digital Pin Voltage and Resistance Values

Table 8 provides the open-circuit DC voltage referenced to ground and resistance value for the control pin listed.

Table 8. Digital Pin Voltages and Resistance

Pin	Name	Open Circuit DC Voltage	Internal Connection
8	STBY	0V	580kΩ resistor to ground

Package Drawings

The package outline drawings are accessible from the Axiro website. The package information is the most current data available.

Ordering Information

Orderable Part Number	Package	MSL Rating	Carrier Type	Temperature
F1421NLGK	4mm x 4mm x 0.9mm 24-pin QFN	1	Tray	-40° to +105°C
F1421NLGK8	4mm x 4mm x 0.9mm 24-pin QFN	1	Reel	-40° to +105°C
F1421EVBI	Evaluation Board			

Marking Diagram

Top Marking Illustration	Marking	Representation
	\$	Factory Code
	Y	Last Digit of the Year
	WW	Work Week
	***	Lot Sequential Code

Revision History

Revision	Revision Date	Description of Change
2.00	Jun 24, 2026	Updated document branding and layout to Axiro Semiconductor standard. No changes to device functionality or specifications.